

A detailed black and white line drawing of various flowers, including roses and peonies, with leaves and stems, filling the background of the page.

# MegPad

**31.5" 4K Mobile Screen with Stand**

## **A32Q7S User Guide**

The contents of the manual are for reference only,  
and everything is subject to the actual product.  
Android is a trademark of Google LLC.

# Contents

---

<b>Safety Warnings and Precautions</b> .....	2
Precautions .....	2
safety warning (stability hazard) .....	2
Important Statement on Network Service .....	2
<b>Packing list</b> .....	3
<b>Product installation</b> .....	4
<b>Adjust angle and height</b> .....	6
<b>Functions Of Keys</b> .....	7
<b>Interface Functions</b> .....	8
<b>Instructions For Use</b> .....	9
Battery .....	9
Notice .....	9
<b>Remote Control</b> .....	10
<b>Basic Operations</b> .....	11
Power-on/Standby .....	11
Touch Operation .....	11
Attention: .....	11
Wireless Network Connection .....	11
Cast Function .....	11
Signal Source .....	11
<b>Technical Specifications</b> .....	12
<b>Product Warranty Card</b> .....	13

# Safety Warnings and Precautions

---

## Precautions

1. Before using the product, please read all instructions carefully.
2. When cleaning the product's screen, be sure to unplug the power cord, turn off the power switch, and wipe the screen with a soft damp cloth. If the screen is still not clean, use an LCD screen cleaner. Do not use liquid cleaning solutions or spray cleaners.
3. Do not use accessories not recommended by the manufacturer, as this may cause danger.
4. When unplugging the power cord, hold the power plug with your hand; do not pull the power cord directly with your hand.
5. This product can only use the type of power supply indicated on its nameplate. If you have any questions about the type of power supply used, please consult the product dealer or the local power supply bureau.
6. Since there is high voltage or other dangers when opening or moving the cabinet, do not repair it yourself. You can contact maintenance personnel with relevant qualifications for comprehensive maintenance.
7. In the following situations, first turn off the socket power, then unplug the power plug from the socket and contact maintenance personnel with relevant qualifications for repair:
  - a. The power cord or power plug is damaged or worn.
  - b. The screen is dropped or the cabinet is damaged.
  - c. When obvious abnormalities appear on the screen, it indicates that maintenance is needed.
8. Please place the product in a well-ventilated environment, away from strong light, high temperature or humidity.
9. Please store the product at a room temperature between 0°C and 40°C. If it exceeds this range, normal use may be affected.

## Safety Tips! (Stability Hazard)

The product may fall, causing serious personal injury. It is recommended to take the following simple preventive measures to avoid this:

- Be sure to use the parts provided by the manufacturer and install them strictly in accordance with the installation method provided by the manufacturer.
- Be sure to place the product on a horizontal ground for use.
- Prevent children from climbing and touching the screen.
- When charging, pay attention to the position of the power cord to avoid being pulled or tripped over.
- Do not place the product in an unstable or tilted position.
- Do not place cloth or other items between the product and the desktop.
- Do not place toys, remote controls and other items that may lure children to climb on the product.

## Important Network Service Statement

All content and services obtained from this product are owned by third parties and are protected by copyright, patent, trademark or other intellectual property laws. These contents and services are only for your personal non-commercial use and shall not be used without the authorization of the content owner or service provider.

Under no circumstances shall the company be liable for any direct, indirect or accidental loss or damage caused to you or any third party by accessing any content or service, any information or third-party software through this product.

Third-party services may be changed, removed or terminated without prior notice. The company does not guarantee or state that certain services or content are accessible at all times.

The company shall not be responsible for any services related to these contents and services at any time, nor shall it assume any customer service responsibilities.

For any questions or service requests related to these contents and services, please contact your content or service provider directly.

# Packing List

---



Monitor ×1

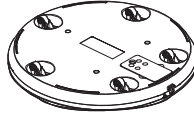

Round chassis ×1

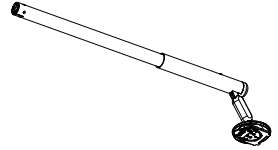

Lifting rod ×1



Power cord ×1

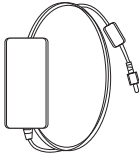

Adapter ×1



Quick Setup Instructions ×1



Manual ×1

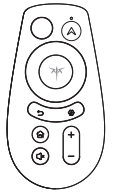

Remote control ×1

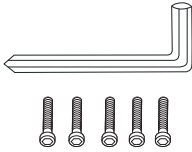

long screws ×5  
(Including a spare screw)  
Hexagon socket wrench×1



Round trim  
(at the rear of the machine)

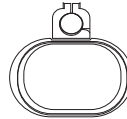

Cover ×1

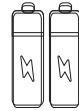

Battery ×2

If any of the above are missing, please contact your product distributor.

Note: Please refer to the actual configuration for specific accessories. Please save all packaging materials for future removal.

# Product Installation

## Bracket Installation Instructions

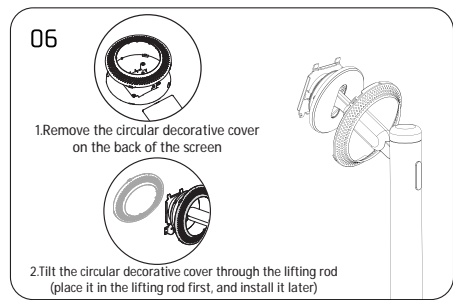
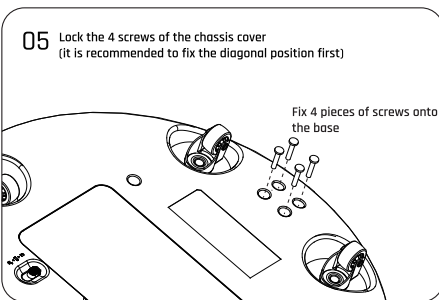
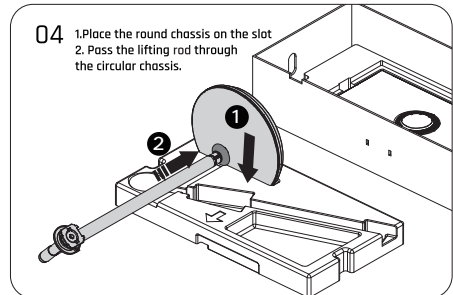
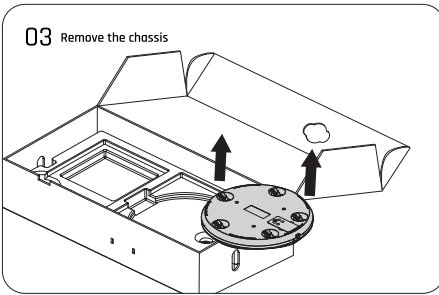
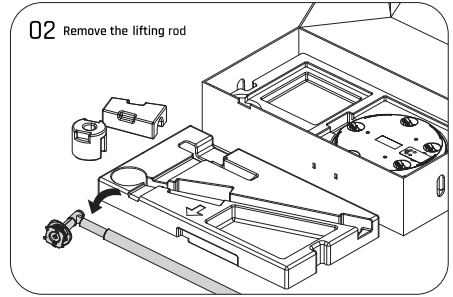
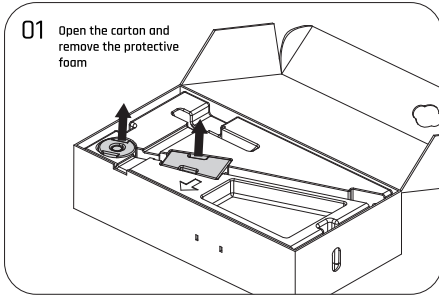

## Base support installation

When assembling, please be sure to tighten the bracket fixing screws, the bracket may fall and cause damage to the product or personal injury.

- The product has a certain weight, please ensure that at least two people work together to assemble it when unpacking and installing.
- Do not use foreign objects (oil, lubricating oil, etc.) on the screws when assembling the product.
- After the product is installed, do not remove the cable holder and screws.
- For daily use, make sure the product is moved in an upright position. If the product is too tilted, there is a risk of tipping over.

This can result in product failure or personal injury.

## On-Screen Installation Instructions

07

1.Remove the wire buckle at the top of the lifting rod

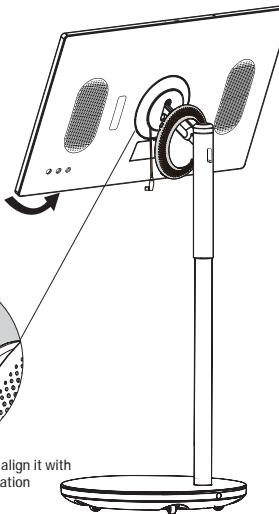

2.Tilt the screen upwards and align it with the card slot for installation

08

1.Twist the power cord counterclockwise

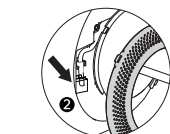

2.Insert and secure the power cord to confirm if it can be turned on (as shown in Figure 10)

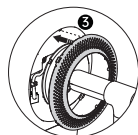

3.Align the card slot at the top of the circular ring with the top of the screen, and press to complete the installation

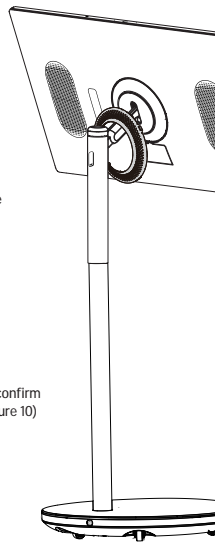

09

1.Use a hex wrench to turn the screw counterclockwise and remove it for future use

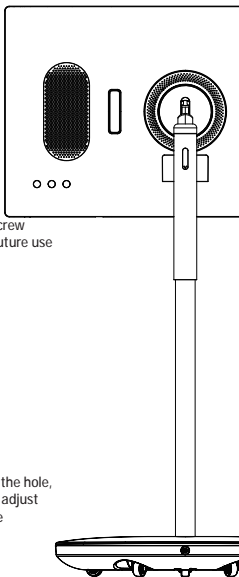
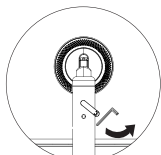

2.Reinstall the silicone plug back into the hole, press the lifting rod to unlock, and adjust it to a suitable height for use

10

Press and hold for 3 seconds to power on

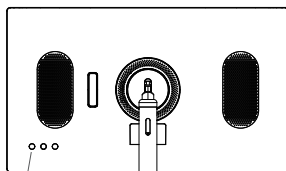

When installing and booting up for the first time, please insert the adapter in advance

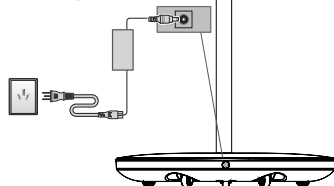

# Adjust angle and height

The height and angle of this product can be adjusted for a comfortable viewing experience.

Note: Some applications do not support vertical display.

Forward tilt angle:  $20\pm 3^\circ$

Backward tilt angle:  $20\pm 3^\circ$

The lifting rod can adjust the height

$200\pm 10\text{mm}$

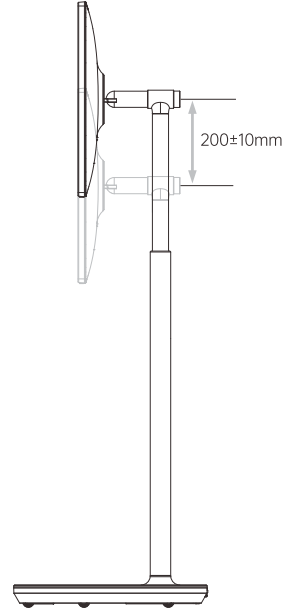
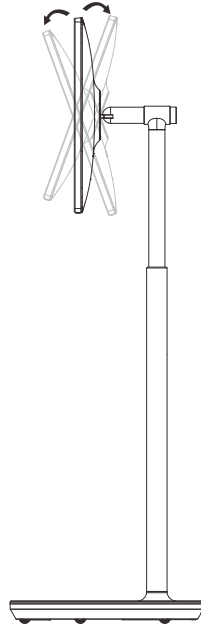
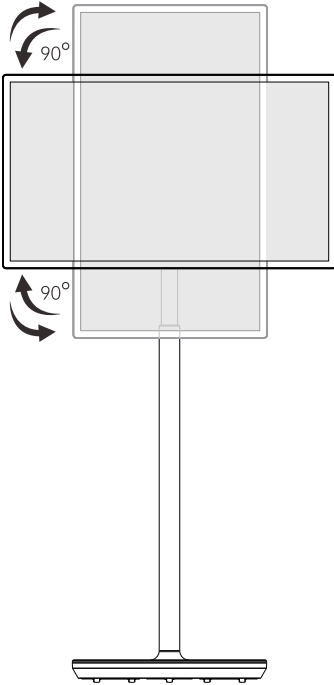

## Caution

- Do not rotate the product beyond its limit angle or exceed the maximum height adjustment range.
- Do not allow your hands or fingers to be caught in the bracket or height adjustment area.

# Functions Of Keys

---





## Functions of Keys

**ON/OFF:** Turn on or off the product.



Power button

- In standby/screen-off mode, press  button to turn on the product.
- During normal working, press  button to enter screen-off state;
- From the drop-down menu on screen, click " > System > Gestures > Press & hold power button", then click "Power menu" or "Digital assistant" to set functions of "Press & hold power button" as needed.



VOL+: Increase the volume.



VOL- : Decrease the volume.

# Interface Functions

---

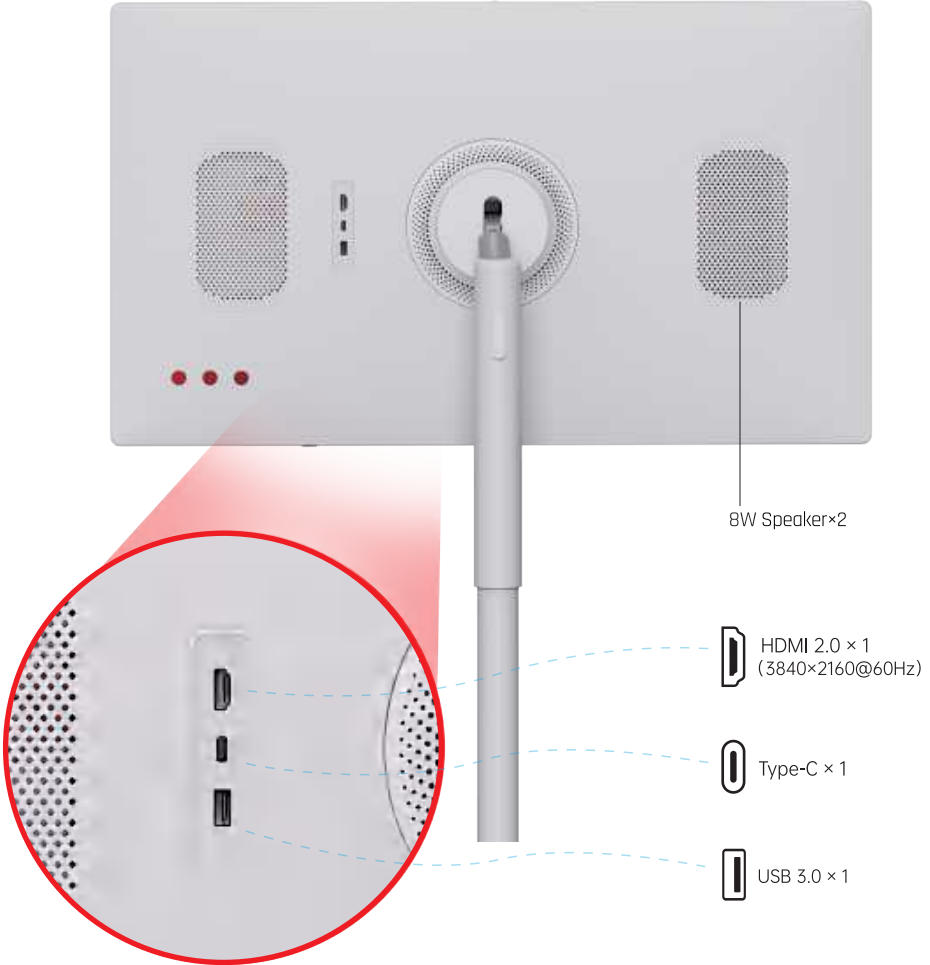

**HDMI :** External Devices Supported external devices include: game consoles, computers, Blu-ray players, high-definition receivers, DVD players, and other external devices.

**Type-C:** Connect the Type-C cable to the Type-C port of this device and the Type-C interface of the external device respectively, and then functions such as Type-C transmission can be used.

**USB:** Can use a USB storage device, or for a mouse and keyboard receiver.

# Instructions For Use

---

## Battery

This product has a built-in battery in the stand and can be used for a period of time without connecting to another power source. When powered on, the power indicator light will display three different states—red, off, or green—depending on the remaining battery level, as shown in the figure below:

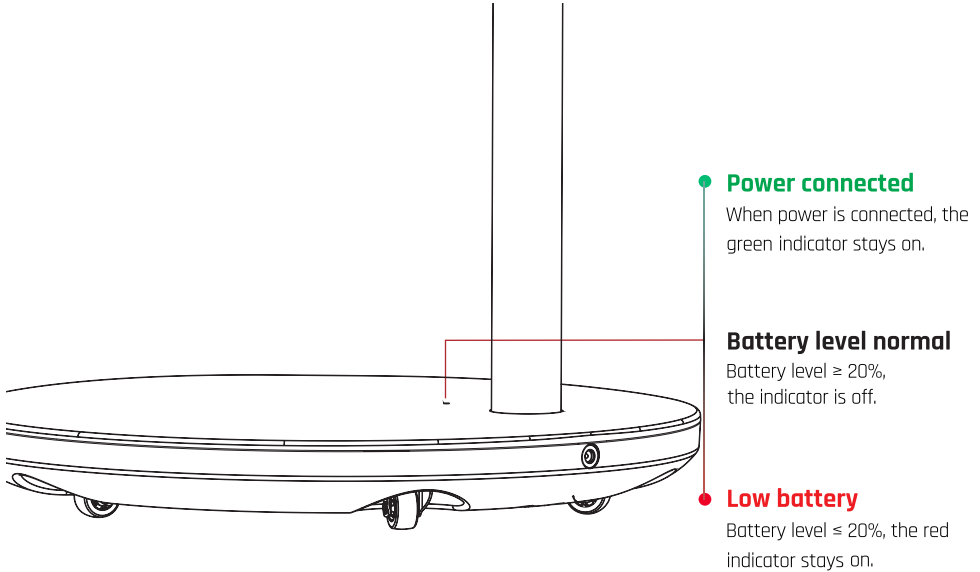

## Notice

- The battery life and usage time after charging will decrease proportionally with the usage time of the product.
- The battery cannot be charged in extreme environments.
- In standby mode, the remaining battery power will also decrease naturally.
- To prolong battery life, it is recommended to charge the battery after a period of use rather than keeping the battery fully charged all the time.
- Keeping the battery at 50% will help extend battery life.
- The maximum usage time is 5 hours after a long battery charge.
- Standard usage times in this manual are based on KTC laboratory values. Therefore actual times may vary depending on usage.
- The usage time may vary depending on various factors such as connected devices, operating temperature, usage time and user settings, etc.

# Remote Control

---



## Flying Squirrel

Toggle the [On/Off] state of the flying squirrel mode.



## Return

Return to the previous level.



## User settings

Enter settings.



## Home Page

Return to the desktop homepage.



## Mute

Mute.



## Volume

Increase the volume.



## Volume

Decrease the volume.



## Arrow keys

Up: Simulate a finger swiping up

Down: Simulate a finger swiping down

Left: Simulate a finger swiping left

Right: Simulate a finger swiping right

 : Confirm the selected content.



## Power

Short press: Turn off the screen.

Long press: Enter the [Shutdown Confirmation Page] or wake up the Google Assistant.

(displayed according to the options set in the settings)



# Basic Operations

---

## Power-on/Standby

Connect the power cord, and Long press the **[Power]** on the back of the product to turn it on. During normal working, swipe down from the top edge, and drop-down menu appears. Click "**☰ >Power off**", then the product enters standby state. Press **[Restart]** can reboot the machine.

## Touch Operation

- Click: Tap on the screen.
- Click and hold: Tap on the screen for 2s or longer.
- Swipe: Swipe on the screen up, down, left and right.
- Drag: Tap and hold the target (e.g., an application) to be moved, then swipe to the desired position.
- Open/close: Place two fingers on the screen, then open or close these fingers to zoom in or out the content displayed on the screen.

**Note:** After the screen is off, double click to make the screen on.

Click "**Settings > System > Gestures > Navigation mode**" to select the system navigation mode.

## Attention:

- Whether the displayed content supports the zoom in/out function is related to the application. Please operate according to the actual condition.
- Avoid pressing the screen with force; where necessary, simply use your fingertip to tap on the desired item. If you wear gloves or use your fingernail to touch the screen, it is possible that the product cannot respond and be operated normally.
- If the screen is a little wet or too damp, the sensor cannot work normally when touching it.

## Wireless Network Connection

Click "**Settings > Network & internet > Internet**", and turn on WiFi; the system will start searching and list the wireless network signals available. Click the network to be connected. The  icon beside a network indicates the network is encrypted; the product can be connected to the network only after you enter the correct password.

**Remark:** More system settings can be done under "Settings" as per need.

## Cast Function

Click "**KShare**"; select the projection mode according to the device used. Perform projection according to different prompts.

## Signal Source

When a device is connected via HDMI, click on "Signal Source" to switch to the HDMI input (the external device must support HDMI screen casting).

# Technical Specifications

Panel size	80.01cm (31.5 inches)
Maximum Resolution	3840×2160@60Hz
Panel type	VA
Backlight type	Side Entry (ELED)
Built-in system	Powered by Android™ 14
Charging interface	19V == 4.74A
Visible area	697.306mm×392.234mm
Viewing angle	178° (H) / 178° (V)
Color gamut	NTSC 1931 90% (Typ.) / 85% (min)
Center luminance of White	250cd/m <sup>2</sup> (Typ.)
Contrast	3000: 1
Speaker	8W×2
Battery capacity	8550mAh/11.1V(94.9Wh)
Product interface	HDMI2.0 *1 Type-C *1 (Full-featured DP-IN, USB2.0, 5V 2A output) USB3.0 *1
Work environment requirements	
Working altitude	≤ 5000m
Working temperature and humidity	0 °C ~ 40 °C      0% ~ 65%(non-condensing)
Storage temperature and humidity	-10 °C ~ 50 °C      0% ~ 80%(non-condensing)

## Low blue light mode

The light emitted by the screen contains blue light, and keeping the eyes on the screen for long periods of time will not only bring visual fatigue, but also may cause eye diseases. Using the low blue light function will reduce blue light and reduce eye fatigue.

The default mode of the product is the low blue light mode, which is certified by the TUV Rheinland hardware method for low blue light.

## Eye care recommendations :

- 1) Do not use the product for a long time without interruption, avoid overuse of the eyes, it is recommended that you take a 10 minute break for every 30 minutes of use.
- 2) When taking a break, you can relax your eyes by looking at distant scenery.
- 3) When taking a break, do eye exercises to relax your eyes.
- 4) Infants under the age of 2 should not watch the screen.

# Product Warranty Card



Customer Name	
Tel	
Address	
Model	
Device Number	
Purchase Date	

## Warranty Rules

1. We provide you with one year free warranty from the date of purchase or as agreed in the contract.
2. The following cases are not covered by the warranty:
  - Failure or damages caused by artificial or natural disasters.
  - Failure caused by not following the operation method and precautions written in the User Guide.
  - Failure caused by user disassembly.
3. The liability scope of the warranty card is limited to the maintenance of the product, without covering any other liability.
4. If you are not sure about the repair and warranty of the machine after the warranty period, please visit the website [US.KTCPLAY.COM](http://US.KTCPLAY.COM) for the warranty policy.



Notice: Please fill out the card and return it to us, when you apply for a warranty.



More Information

Please scan QR code or visit [US.KTCPLAY.COM](https://US.KTCPLAY.COM)

**Any question or comments. Please contact:**

[support@kctcplay.com](mailto:support@kctcplay.com)

[support.eu@kctcplay.com](mailto:support.eu@kctcplay.com) [Europe]

To care for and protect the earth better, please send it to a local manufacturer with nationally recognized qualification for recycling according to the national applicable laws and regulations on recycling of waste electrical and electronic products when you no longer need this product or at the end of its service life.

**HDMI™**

**The terms HDMI and HDMI High-Definition Multimedia Interface, and the HDMI Logo are trademarks or registered trademarks of HDMI Licensing Administrator, Inc. in the United States and other countries.**